

THERMOGRAVIMETRY/MAGNETOMETRY WITH A CAHN TA450 ELECTRONIC ANALYTICAL BALANCE INTERFACED WITH AN APPLE II+ COMPUTER

J.A. FERGUSON *, S.K. SILBER, M. HYMAN and M.W. ROWE

Department of Chemistry, Texas A&M University, College Station, TX 77843-3255 (U.S.A.)

(Received 25 September 1989)

ABSTRACT

We have constructed an inexpensive computer-assisted thermogravimetric/magnetic balance utilizing a Cahn TA450 electronic analytical balance and an Apple II+ personal computer, both of which were already available in an undergraduate laboratory. Some details of the hardware and software interfacing necessary to make the apparatus work are presented. The balance was then tested with a number of magnetic, thermogravimetric and thermomagnetic applications. The results of the tests demonstrate the utility of the thermomagnetic balance as it was constructed. It compared favorably with our research grade thermomagnetic balance.

INTRODUCTION

Thermogravimetry has continued to find increasing utilization in chemistry and geology [1]. Thermomagnetic analysis is useful for characterizing the magnetic constituents of geological [2] and cosmochemical [3] samples. Good commercial instruments with computer-assisted operation are available, but all are rather expensive. This paper describes the construction of a computer-assisted thermogravimetric balance using a Cahn TA450 electronic analytical balance which can utilize a permanent magnetic having Faraday-shaped poles for thermomagnetic analysis, and uses an Apple II+ microcomputer for operator prompting and for data collection and reduction. The accuracy and reliability of the system is demonstrated to be good.

BALANCE ALTERATIONS

Alterations necessary to change the analytical balance into a thermogravimetric/thermomagnetic balance are minor. The air-draft hood is removed

* Present address: Florida Department of Agriculture, Division of Chemistry, 3125 Conner Blvd., Tallahassee, FL 32399-1650, U.S.A.

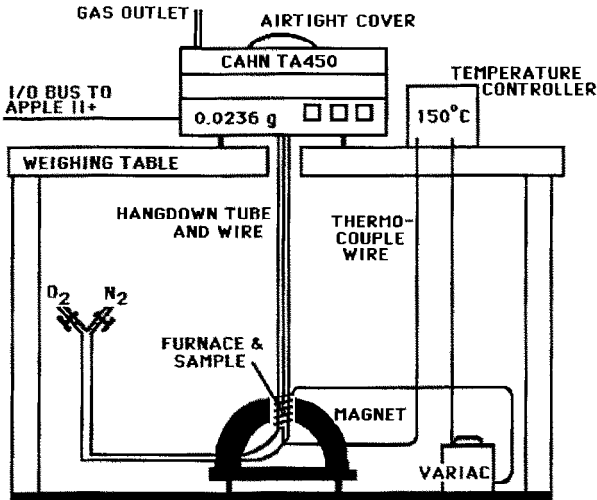

Fig. 1. The Cahn TA450 electronic analytical balance with thermogravimetric and thermomagnetic capabilities.

and a gas outlet is put into the top of the case. All other air leaks are sealed. The Cahn TA450 balance comes equipped with the capability of suspending the weight from below. A hangdown wire (non-magnetic) is suspended from the balance and a hangdown tube is attached to the bottom of the balance case. A sample is then suspended from the hangdown wire and surrounded by the appropriate heater as is usual in thermogravimetry and thermomagnetometry. The gas inlet is then attached to the bottom of the furnace to allow the introduction of both inert and reactive gases. Figure 1 shows the altered balance schematically, as we have it set up.

HARDWARE INTERFACE

The Cahn TA450 electronic analytical balance consists of four parts: (1) the decoder circuits which decode the lowest three address lines to generate enable strobes for the remainder of the interface; (2) an output to the Cahn balance control functions: TARE, ZERO and RECALL; (3) an input from the balance to buffer the binary-coded decimal weight; and (4) three interval timers with 1, 10 and 60 s intervals. To allow the balance to communicate with the computer, it was necessary to construct an interface card. Figure 2 shows the complete schematic diagram for our hand-wired interface card. Only six of the eight available data lines are necessary for the interface, which reduces the number of tri-state buffer chips needed. In the following, hexadecimal numbers are preceded by a \$; all other numbers are decimal.

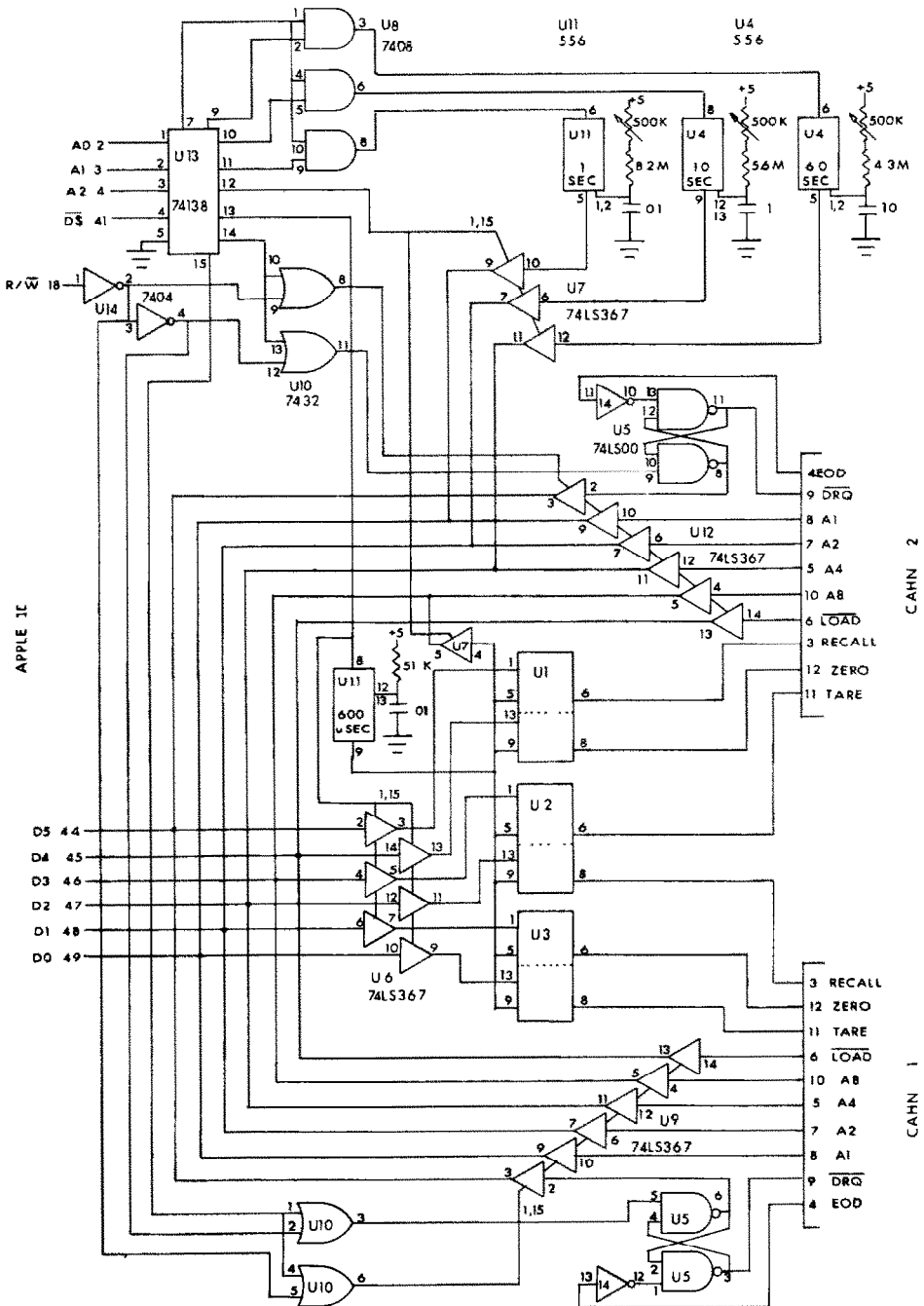

Fig. 2. Schematic diagram of the hand-wired card which permitted communication between the Cahn TA450 electronic analytical balance and the Apple II+ computer for the applications described herein.

TABLE 1

Summary of the function of the eight enable lines

Base address		(\$C0B0)	–	Selects balance # 1
Base address	+ 1	(\$C0B1)	–	Selects balance # 2
Base address	+ 2	(\$C0B2)	–	Output control functions
Base address	+ 3	(\$C0B3)	–	Read timer status
Base address	+ 4	(\$C0B4)	–	Start timer # 1
Base address	+ 5	(\$C0B5)	–	Start timer # 2
Base address	+ 6	(\$C0B6)	–	Start timer # 3
Base address	+ 7	(\$C0B7)	–	Start all three timers

Address decoder

Address decoding is done primarily by U13, a 74LS138, 3 line to 8 line decoder. Address lines A0, A1 and A2 are decoded into eight separate device-enable lines. The base address is selected by the device-select line on the Apple I/O bus. Therefore, the base address is a function of the slot into which the board is plugged. Assuming the card is in slot 3, the base address is at \$C0B0, and the last effective address is \$C0B7. Since address line A4 is not decoded and addresses \$C0B8 through \$C0BF are also allocated to slot 3, these addresses can be used with no difference in performance. Table 1 summarizes the function of the eight enable lines.

Since the decoder is enabled by the Apple device-select pulse, all the device-enable pulses are nominally 450 microseconds wide and are true when asserted low.

Balance control functions

The balance has three control functions: TARE, ZERO and RECALL. TARE clears the balance display and internal memory. ZERO clears the display after adding the current value to a running total in memory. RECALL alternately displays the total weight added and the last weight entered, when repeatedly used. Normally, these functions are controlled by push buttons on the front panel; under computer control, they are executed by asserting the appropriate control on low for at least 600 μ s.

Three data lines are sufficient to control the balance. Each line is buffered by a gate of U6, a 74LS367 tri-state buffer, which is enabled by the third device-enable line. A pair of NAND gates from U1, U2 or U3 are used as a flip-flop to hold each bit and send it to the balance. The device-select line triggers half of U11; a 556-type one-shot multivibrator is also placed on bit 3 of the data bus through one of the tri-state buffers associated with reading the timers. This line can then be monitored to determine when a control function is finished. Since a NAND gate flip-flop requires negative-going

TABLE 2

The bit positions, the binary weights and the functions controlled

Bit	Binary weight	Function
0	1	TARE balance #1
1	2	ZERO balance #1
2	4	RECALL balance #1

pulses to set and reset, it is necessary to put a 0 in the bit position of the function to be executed, and a 1 in all other positions. This can be most easily achieved by subtracting the non-inverted value from 255. Table 2 indicates the bit positions, binary weights and the functions which are controlled.

The balance reading must be stable before the balance will TARE reliably, so it is necessary to either (1) read the balance to assure stability, or (2) to read it after, to verify a ZERO reading, and TARE again if necessary.

Cahn balance input

To read data from the Cahn balance, it is necessary to assert the data-request line low. When the balance reading is stable (i.e., the least significant digit is displayed) the balance puts each digit on the four binary-coded-decimal (BCD) lines and pulses the load line low for approximately 100 μ m. Eight digits are strobed out this way, about one every 3 ms, and then the end-of-data line is pulsed high to terminate the data transfer.

The input hardware acts only to buffer the data lines. The data must be received and reconstructed under program control. The read/write line is used to distinguish between starting and reading the balance. If a write operation is performed to the balance address, a NAND gate flip-flop, U5, is set. The negative logic output goes to the balance as the data-request signal and the positive logic output goes back to the computer as a busy signal on bus bit 5. Thus, the computer can determine whether or not the data-request is asserted. This flip-flop is reset by the end-of-data pulse from the balance. The load line and four BCD lines are passed directly through tri-state buffers, U9 or U12, to the data bus. In reading the balance address, the lowest four bits are the BCD data, bit four is the load signal, and bit five is the busy signal. The software must wait for the load line to go low and then read and mask the lowest four bits to get each digit. The BCD lines do not contain valid data when the line is high.

Interval timers

Three one-shot multivibrators, U4 and half of U11, are used as interval timers. These timers are adjusted 1, 10 and 60 s intervals and can be

TABLE 3

Timer and binary weight associated with each bit of the timer port

Bit	Binary weight	Timer
0	1	1 s
1	2	10 s
2	4	60 s
3	8	600 μ s

triggered either simultaneously or individually. These three timers plus the 600 μ s timer on the balance control port are read from base address + 3.

The outputs are high while the timers are running and go back low when they time out. Table 3 shows the timer associated with each bit of the timer port. These analog timers, not precisely adjusted, are suitable only for approximate interval measurements. Since there is a variable delay in the Cahn balance before it transmits a measurement, they are quite adequate for timing events involving the balance.

SOFTWARE INTERFACE

The Cahn hardware interface is a buffer system that provides no help in interpreting data from the balance. It is necessary, therefore, to provide a software routine to properly operate the balance through the hardware interface. Due to the speed of the balance (3 ms per digit) and the slowness of BASIC, it is necessary to drive the interface by machine language routines at the lowest level, and to then link these to BASIC.

The software we used is a complete application for performing both thermogravimetric analysis of coal or lignite (i.e., proximate analysis) and thermomagnetic analysis. Only those portions of the program directly concerned with interfacing the balance will be discussed. The remainder of the program is straightforward BASIC code and its discussion is not within the scope of this paper. There are three distinct pieces of machine language code that will be discussed separately, one of which also requires a BASIC routine to operate properly. Each machine language routine and its interface to BASIC will be discussed in turn. Machine language routines implemented in our system and the BASIC linkages to these routines are available on request.

Balance control interface

This machine language routine takes an argument passed through memory location \$478 (1147), complements it, and directs it to the balance

control port. The routine waits for the 600 μ s timer to time out and then exits. It is not necessary to perform this function in machine language. The main reason for doing so is the ease of complementing the bit pattern and making it invisible to the user.

User function routine

The second piece of machine language code is a USR function written to take the logical AND between two 8-bit bytes. The two bytes to be ANDed are passed to the routine as the high and low order bytes of an integer. Since all arguments are passed from BASIC as floating point numbers, the USR function first calls a BASIC routine to convert to fixed point format. The high and low bytes are then ANDed together, and the result converted back to floating point format for BASIC. This routine can be called anywhere to AND two values, A and B , both less than or equal to 255: $AND = USR (A * 256 + B)$. This routine is necessary to generate control bit patterns.

Balance input routine

This routine is the most complex, and must be done in machine language due to the speed limitations of BASIC. Once the balance begins to transmit digits, it continues until all have been sent. Our approach was to write a short machine language routine to start the balance, read the digits, and store them in a buffer. After all the digits have been received, control is transferred to the BASIC portion of the routine which then reconstructs the weight. The machine language routine starts at \$328 (808). The balance-read operation is initiated with the STA operation and the routine then falls into a digit-catching loop. First, the balance is read and the load bit is masked. This is repeated until the load bit is 0. Then the balance is read again and the four bits are saved in the buffer. After eight digits have been received, the routine exits.

To read the balance, the machine language routine is called to fill the digit buffer with a current weight. The weight variable, WT, is zeroed, and a loop set up to add each digit to the running sum. The loop index is used to access each digit which is added to the old weight multiplied by 10. The eighth digit transmitted by the balance is used to encode conditions. Bit 3 is set if the minus sign is illuminated and bit 2 is set if there has been an overflow. These two conditions are tested for an appropriate action. Bits 0 and 1 are used to encode the decimal point position which is always fixed, so these bits are ignored. The weight is divided by 10 000 in order to return a weight in grams instead of tenths of milligrams. If the minus sign is illuminated, the weight is negated, and if an overflow occurred, a message is printed and the WT variable set equal to 1 000 000.

Timer routines

The timers are interfaced in high-level code. All that is required is to start the desired timer with a POKE to the appropriate address and then to wait for it to time out with a WAIT instruction. In addition, a routine is used to delay for any period of time, based on the variables Z60, Z10 and ZZ, the number of necessary 60, 10 or 1 s delays, respectively. Details of all these programs are available on request.

DEMONSTRATION OF ACCURACY AND RELIABILITY

Thermogravimetry: proximate analysis of coal and lignite

In our application, the software calculates the proximate analysis values of the coal or lignite [4] and instructs the operator when to change the temperature and/or gases in the furnace. An example of a thermogram obtained is shown in Fig. 3. The proximate values in our program are reported as percentages of the total sample and are calculated as usual as [4]

$$\% \text{ moisture} = 100[(W_i - W_2)/W_i] \quad (1)$$

$$\% \text{ volatile matter} = 100[(W_2 - W_3)/W_i] \quad (2)$$

$$\% \text{ fixed carbon} = 100[(W_3 - W_f)/W_i] \quad (3)$$

$$\% \text{ ash} = 100(W_f/W_i) \quad (4)$$

as shown in Fig. 3 which is a copy of our computer-generated plot of the proximate analysis of a Texas lignite, where W_i is the initial weight, W_2 is the weight at the first plateau, after heating to 105°C , W_3 is the weight at the second plateau, arrived at by heating to $\geq 750^\circ\text{C}$ under high-purity dry nitrogen or argon, and W_f is the final weight after exposing the sample to air

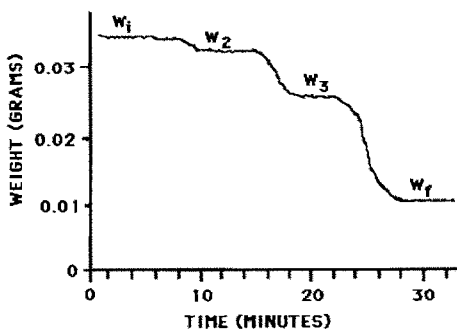

Fig. 3. A faithful tracing of a computer-generated plot of the proximate analysis of a lignite conducted on the altered Cahn TA450 described here.

or oxygen at 750°C. The system was tested by giving several undergraduate students approximately ten minutes instruction and then having them do proximate analyses on three coal and/or lignite samples. In all cases, agreement with the Pennsylvania State University Coal Research Section's values [5] was acceptable, i.e., differing from the Penn State values by only a per cent or two, or close to the same uncertainty as the research thermoanalytical methods for proximate analysis [4].

Magnetogravimetry: magnetite determination in carbonaceous meteorites

We have used a Cahn RG-2000 thermobalance in our laboratory over the past several years for several applications. In one of them, Hyman and Rowe [6] measured the magnetite in a number of carbonaceous meteorites by magnetogravimetry. The magnetite contents were measured by weighing the sample and then measuring the saturation magnetization with a Faraday measurement, i.e., the weight was taken in the presence of a strong magnetic field, 4.66 kOe in this case, with the magnet having Faraday-shaped poles.

Many methods are available for the measurement of magnetic susceptibility and saturation magnetization. The Faraday method is one of the most sensitive and convenient. It is based on the measurement of the force acting on a body when it is placed in a non-uniform magnetic field with an axis of symmetry x . The strength of the field H changes rapidly with displacement along this axis. The instrument designed for these measurements is called a magnetic balance. Specially designed pole caps on the magnet produce a region where the product of the field strength H and field gradient dH/dx is constant. The sample must be small enough so that its entire volume can be located in this region. The force acting on the body along the axis of symmetry is then given by

$$F = \chi m H (dH/dx) \quad (5)$$

where m is the apparent weight change, χ is the magnetic susceptibility (e.m.u. g^{-1}); H is the magnetic field (oersted), and dH/dx is a maximum. The force of attraction between the sample and the external field causes the balance to record a maximum apparent weight many times the actual sample weight (Fig. 4).

Thus the saturation magnetization of magnetite in a non-magnetic matrix is directly proportional to the magnetic content of the meteorite sample. It follows that

$$\sigma_s = \sigma_{Ni} (\Delta_{W_s} - \Delta_{W_q}) W_{Ni} / (\Delta_{W_{Ni}} - \Delta_{W_q}) W_s \quad (6)$$

where σ_s is the specific saturation magnetization of the unknown, a carbonaceous meteorite sample, σ_{Ni} is the saturation magnetization of a standard (here pure nickel), W_s is the weight of the sample, W_{Ni} is the weight of the nickel standard, and W_q is the weight of the quartz sample holder. The Δ s

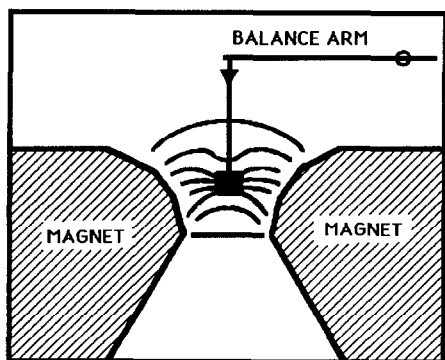

Fig. 4. Schematic diagram indicating the weight increase of a ferromagnetic material suspended within a magnetic field created by a magnet with pole faces shaped for Faraday analysis.

refer to the differences in weights when the magnet is in place and when it is removed. Since we are dealing with a ferri- and ferro-magnetic species in magnetite and nickel, respectively, the change in the apparent weight of the quartz container is negligible. Similarly, the much more weakly magnetic components of the sample can be ignored.

The magnetite contents of two of the meteorites measured earlier [6] were remeasured here using the Cahn TA450 analytical balance altered as described above. Samples were placed in a quartz pan suspended from the hangdown wire of non-magnetic material. These samples can range in form from fine powders to bulk pieces. The sample pan was carefully positioned to meet the requirements of maximum and constant $H \, dH/dx$ over the volume occupied by the specimen sample. The sample mass was read directly from either the computer or the balance display. When the external field is in place, the apparent weight is recorded in the same fashion. The calculation of the magnetite (Fe_3O_4) reduces to

$$\% \text{Fe}_3\text{O}_4 = (\sigma_s / \sigma_m) \times 100 \quad (7)$$

where σ_m is 92 e.m.u. g^{-1} , the saturation magnetization of pure magnetite. The values for the magnetite contents of the Orgueil and the Ivuna carbonaceous meteorites measured on our Cahn RG-2000 thermomagnetic balance and the altered, computer-assisted Cahn TA450 are shown in Table 4. Agreement was good. The TA450 even has the advantage of a larger capacity, and, therefore, allows a larger sample to be run; it was not as accurate for very small samples, however. For this application, the balance was operated manually, i.e. without computer assistance, except that the weight (or apparent weight with the magnet in place) could be read by the computer if desired.

TABLE 4

Comparison of the altered, computer-assisted electronic analytical balance with our research grade magnetic balance for measurement of the magnetite contents of carbonaceous meteorites

Sample	Cahn RG-2000 % magnetite [6]	Cahn TA450 % magnetite
Ivuna	10.7 ± 0.3	11.3 ± 0.2
Orgueil	10.7 ± 0.6	10.3 ± 0.8

Thermogravimetry: calcium oxalate monohydrate

The pyrolysis of calcium oxalate monohydrate, long a standard for thermogravimetry, was first published by Peltier and Duval [7] who suggested that it could be used as a reference substance for judging the performance of a thermobalance. We therefore decided to use it for our third test of the altered TA450 thermobalance. Due to the limitation of our furnace, the temperature was constrained to be < 750 °C. The degradation of calcium oxalate ($\text{CaC}_2\text{O}_4 \cdot \text{H}_2\text{O}$) proceeds as follows

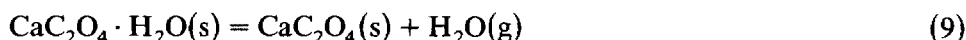
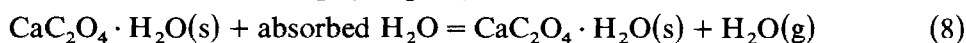

The last step could not be performed with our balance because of the temperature constraint placed by our heater construction. The expected stoichiometric losses due to release of bound H_2O and then CO are 12.3% and 19.2% of the dried (at 105 °C) weight, respectively. The losses, experimentally determined with the altered Cahn TA450, were $(12.3 \pm 0.1)\%$ for bound H_2O and $(19.2 \pm 0.3)\%$ for CO . Here, the agreement was exceptional, especially since an error of ± 1 in the tenths of milligrams digit would produce an error of between 0.1 and 0.2 percent for the sample sizes used.

Thermomagnetic analysis: magnetic minerals in meteorites

Thermomagnetic analysis is often used in geology in paleomagnetic determinations to ascertain the identity of the magnetic minerals present in a rock. In our own studies, we utilized magnetogravimetry to measure the magnetite contents of carbonaceous meteorites (see above). In that work, it was first necessary to demonstrate that the only magnetic mineral of consequence present in the samples was magnetite. This was done by thermomagnetic analysis using a Cahn 2000 thermomagnetic balance; here we have repeated such measurements using the altered Cahn TA450 analytical balance described earlier. Figure 5 shows the schematic thermomagnetic curves for two carbonaceous meteorite samples (Orgueil and North Haig)

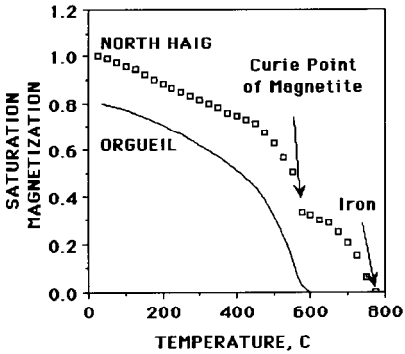

Fig. 5. Thermomagnetic analysis curve for the Orgueil and North Haig carbonaceous meteorites. The curve for Orgueil indicates that the only magnetic mineral of significance is magnetite. The strong inflection in the curve for North Haig at about 590°C is also indicative of the presence of magnetite in that meteorite. However, the continuance of the curve to temperatures higher than the Curie temperature of magnetite shows the presence of another magnetic substance. The final Curie point at ~ 790°C indicates that Ni-free metallic iron is also present in the North Haig sample.

run in pure nitrogen. The heating and cooling curves for each meteorite corresponded closely to one another and only the heating curve is shown. The Curie point of ~ 595°C observed for Orgueil agrees with the expected curve for magnetite only, no other magnetic material being indicated, making that an acceptable candidate for measuring its magnetite content. The fact that the cooling curve and the heating curve were very nearly the same in each case simply indicates that the nitrogen gas was sufficient to keep the magnetic minerals in Orgueil and North Haig from converting to different oxidation states, i.e. Fe_3O_4 to Fe or vice versa, for example. The thermomagnetic curve for the North Haig carbonaceous meteorite, however, is quite different from that for Orgueil. In this case, the curve indicates two, not just one, Curie temperatures. For North Haig, the curve thus demonstrates the presence of two magnetic species magnetite and metallic iron. Once again the altered TA450 electronic analytical balance worked well in this thermomagnetic application.

Hyman and Rowe [8] recently utilized the thermomagnetic balance described in this work to examine the cause of the red and black coloration of American Indian pottery. They were able to demonstrate that, somewhat unexpectedly, the black color was not due to magnetite (unless the particle size was smaller than 300 nm). The red color was shown by thermo-magnetic analysis to be caused by the presence of hematite, as expected.

CONCLUSION

An Apple II+ microcomputer has been interfaced with a slightly altered Cahn TA450 electronic analytical balance to produce a computer-assisted

thermal balance capable of thermomagnetometry and thermogravimetry when used with appropriate magnets and furnaces. The system has been demonstrated to work well through a variety of applications.

ACKNOWLEDGMENTS

We are grateful to the Robert A. Welch Foundation, the National Science Foundation and the American Chemical Society and the Center for Energy and Mineral Resources of the Texas A&M University for partial support of this work.

REFERENCES

- 1 W.W. Wendlandt, *Thermal Analysis*, 3rd edn., J. Wiley and Sons, Inc., New York, 1986; C.M. Earnest (Ed.), *Proc. Symp. Compositional Analysis by Thermogravimetry*, ASTM, Philadelphia, 1988.
- 2 E.E. Larson, R.P. Hoblitt and D.E. Watson, *Geophys. J. Roy. Astr. Soc.*, 43 (1975) 607; P.K. Gallagher and S. St. J. Warne, *Thermochim. Acta*, 43 (1981) 253 and *Mat. Res. Bull.*, 16 (1981) 141; M. Hyman and M.W. Rowe, in B.D. Blaustein et al. (Eds.), *New Approaches in Coal Chemistry*, American Chemical Society, Washington, DC, 1981, p. 389; K.J.D. MacKenzie, C.M. Cardile and I.W.M. Brown, *Thermochim. Acta*, 136 (1988) 247.
- 3 J.M. Herndon, M.W. Rowe, E.E. Larson and D.E. Watson, *Earth Planet. Sci. Lett.*, 29 (1976) 283; M. Funaki, I. Taguchi, J. Danon, T. Nagata and Y. Kondo, *Proc. NIPR Symp. Antarct. Meteorites*, 1 (1988) 231.
- 4 R.L. Fyans, Perkin-Elmer Thermal Analysis Application Study 21, 1977; M. Hyman and M.W. Rowe, *New Approaches in Coal Chemistry*, ACS Symp. Series, American Chemical Society, Washington, DC, 1981, p. 389; D.M. Aylmer and M.W. Rowe, in B. Miller (Ed.), *Thermal Analysis*, Wiley, New York, 1982, p. 1270; M. Ottaway, *Fuel*, 61 (1982) 713; J.W. Cumming and J. Laughlin, *Thermochim. Acta*, 57 (1982) 253; J.P. Elder, *Fuel*, 62 (1983) 580; K. Rajeshkar, *Thermochim. Acta*, 63 (1983) 97; D.M. Aylmer and M.W. Rowe, *Thermochim. Acta*, 78 (1984) 81.
- 5 Pennsylvania State University Coal Research Section of the College of Earth and Mineral Sciences, University Park, PA, 16802, data sheets on PSOC coal and lignite samples.
- 6 M. Hyman and M.W. Rowe, *J. Geophys. Res.*, 88 (1983) A736; M. Hyman and M.W. Rowe, *Meteoritics*, 21 (1986) 1.
- 7 S. Peltier and C. Duval, *Anal. Chim. Acta*, 1 (1947) 345.
- 8 M. Hyman and M.W. Rowe, *Texas J. Sci.*, 42 (1990) in press.